

OWNER'S MANUAL

LOCK-N-LOAD®

RIFLE

BULLET

FEEDER

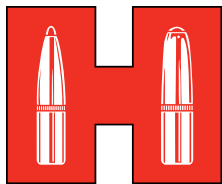

Hornady®
Accurate. Deadly. Dependable.

Lock-N-Load® Rifle Bullet Feeder

PARTS LIST

Item No.	Production Part No.	Qty.	Description
1	399213	1	Tube Spring Clamp
2	399210	1	Button Head Cap Screw (BHCS) 10-32 X 1/4
3	392011	2	Hex Nut, 10-32, Zinc
4	399209	1	Steel Knurled Thumb Screw
5	399353	1	Bullet Drop Funnel, 22 Cal
6	399205	1	Screw Adjustment Bullet Feed
7	399206	1	Screw Lock Nut Adjustment
8	398067	1	Rubber Flat Washer
9	399208	1	Center Plate Adjustment Nut
10	398400	1	Thumb Screw, 1/4-20 X 1/2
11	399355	1	Bullet Guide Plate
12	398401	2	Flat Head Socket Cap Screw (FHSCS), 10-32 X 1/4
13	399351	1	Bullet Feeder Wheel, 22 Cal
14	399212	3	Hex Nut, 1/4-20
15	398402	1	Idler Gear Shaft
16	399218	1	Spur Gear 1.50 P.D., 30 Tooth
17	399102	1	Spur Gear 1.20 P.D., 24 Tooth
18	399207	1	Center Pin Bullet Plate
19	399203	1	Bullet Feeder Base Plate
20	398313	8	Flat Head Socket Cap Screw (FHSCS), 10-32 X 3/4

Item No.	Production Part No.	Qty.	Description
21	399244	1	Flat Head Socket Cap Screw (FHSCS), 1/4-20 X 1/2
22	398381	1	Pin Spirol, 1/8 X 3/4
23	399357	1	Motor 12V DC, RBF
24	399200	1	Bullet Feed Hopper
25	399242	6	Wing Nut, 1/4-20
26	399222	2	Bullet Wiper Screw
27	399223	2	Bullet Feed Wiper Spring
28	399224	2	Thumb Screw, 8-32 X 1/2
29	399211	2	Socket Head Cap Screw (SHCS) 1/4-20 X 2
30	390128	6	Flat Washer, 1/4"
31	398418	1	Bushing (HEYCO 1147), Black
32	398332	1	2 Position Switch
33	399361	1	Power Jack Assembly
34	399164	1	12V 1.0A Power Supply
35	399348	1	Shut-off Switch Cable
36	399358	1	Support Tube - Bottom
37	399359	1	Support Tube - Top
38	399360	2	1" Square Finishing Plug
39	399362	2	Carriage Bolt, 1/4-20x2.5

Lock-N-Load® Rifle Bullet Feeder

EXPLODED VIEW

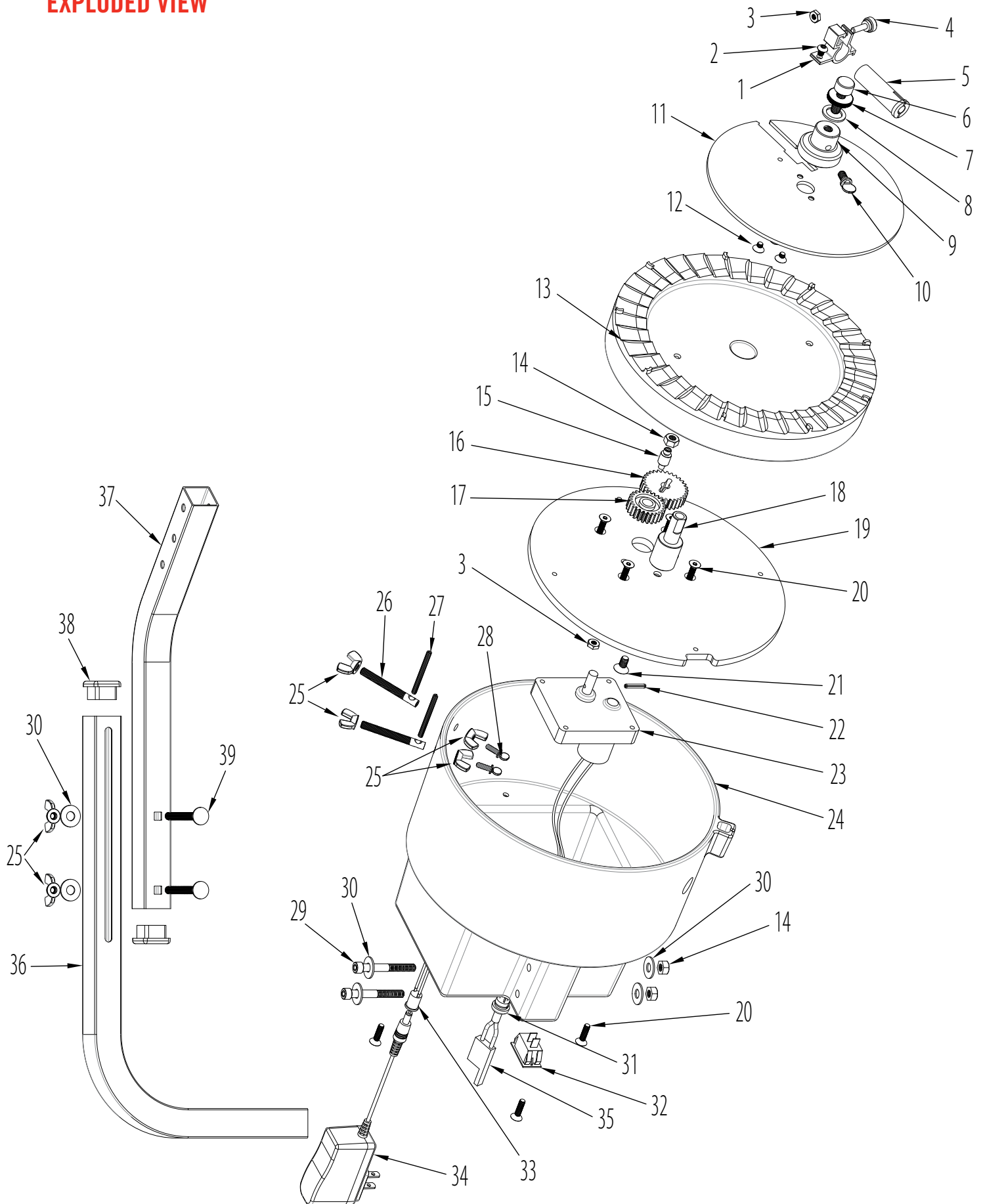

Hopper Installation and Setup

Support Tube Installation

1 Place the Hornady® Lock-N-Load® AP™ template (*located in the back of the manual*) on the table in the location you would like to mount the press and the Lock-N-Load® Rifle Bullet Feeder. Drill $\frac{1}{4}$ " holes for the placement of the Bottom Support Tube (36).

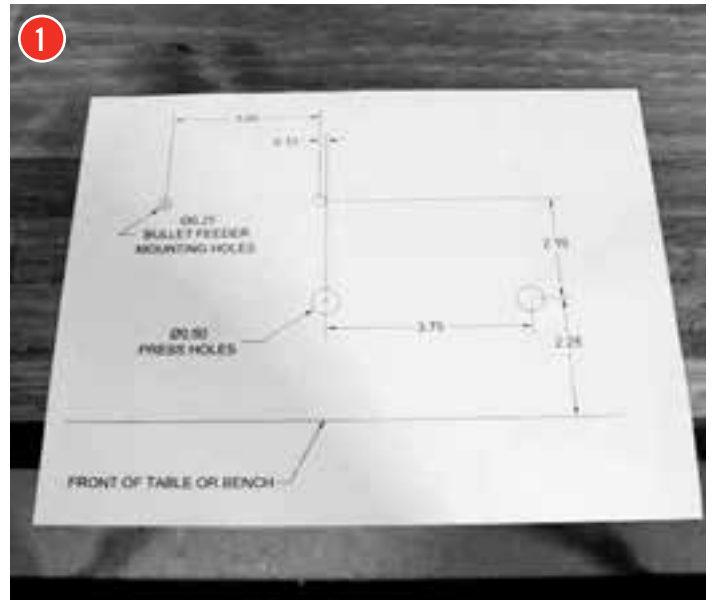

2 Use $\frac{1}{4}$ " bolts with $\frac{1}{4}$ " flat washers (*Not provided, due to the varying thicknesses of tables*) on top of the Bottom Support Tube (36) and also one on the bottom of the bench. Tighten snug.



3 Place a $\frac{1}{4}$ -20 x 2.5" Carriage Bolt (39) into each of the square holes of the Top Support Tube (37). Slide them through the slot on the front side of the Bottom Support Tube (36).

Place a $\frac{1}{4}$ " Washer (30) and $\frac{1}{4}$ -20 Wing Nut (25) on each $\frac{1}{4}$ -20 x 2.5" Carriage Bolt (39). Snug the wing nuts finger tight. The height will need to be adjusted at a later time.

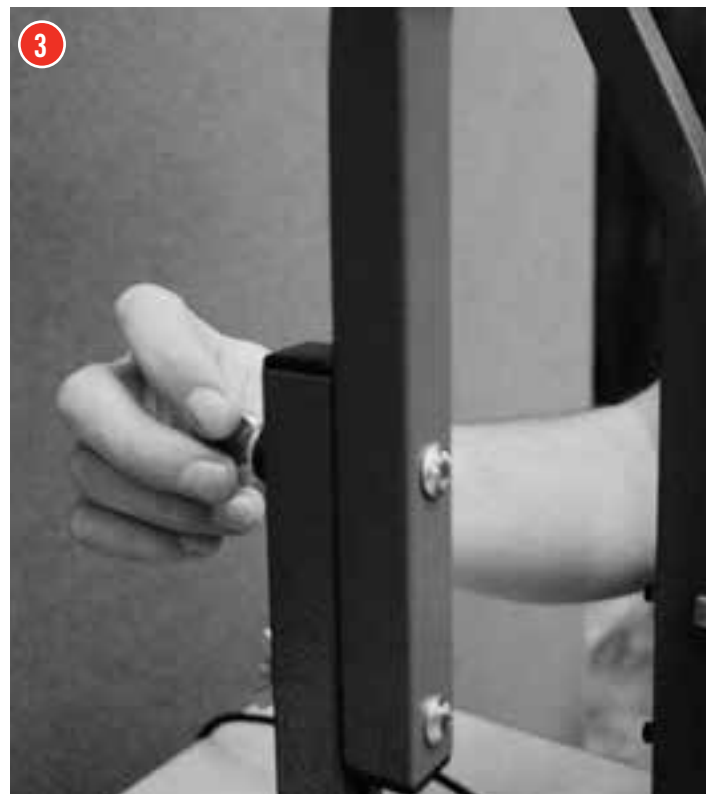

Hopper Installation

Slide the hopper onto the Top Support Tube (29), with the hopper opening facing the front of the bench.

Place a ¼-20 x 2 SHCS Bolt (29) with one ¼" Flat Washer (30) through the middle and bottom holes of the Bullet Feed Hopper (29) and the Top Support Tube (37).

- 4 Place a ¼" Flat Washer (30) then a ¼-20 Hex Nut (14) onto the end of each of the ¼-20 x 2 SHCS Bolts (29) and tighten snug.

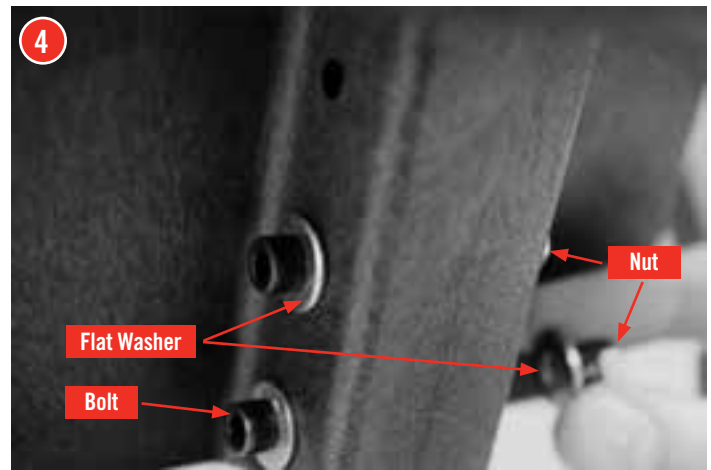

Hopper Setup

- 5 Loosen ¼-20 Thumb Screw (10) and the Lock Nut (7) on the Adjustment Screw (6).

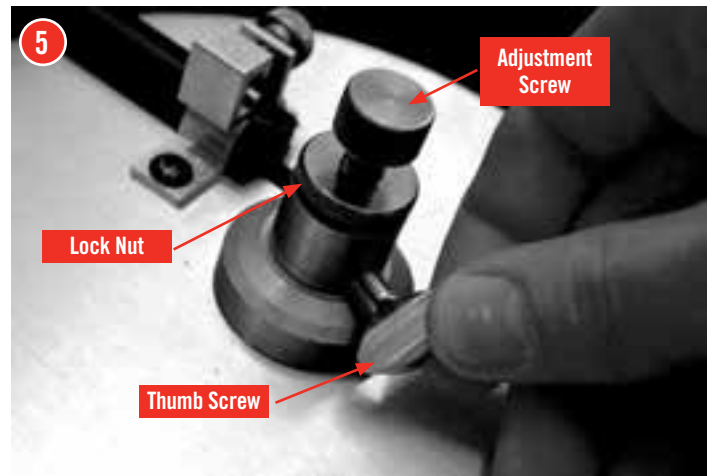

- 6 Raise the Bullet Guide Plate (11) by turning the Adjustment Screw (6) clockwise far enough to hold a bullet base first against the Bullet Guide Plate (11). You will need to adjust the Bullet Guide Plate up or down to get a bullet to feed base first, but fall off if the bullet is nose first. Tighten the Lock Nut (7) once set.

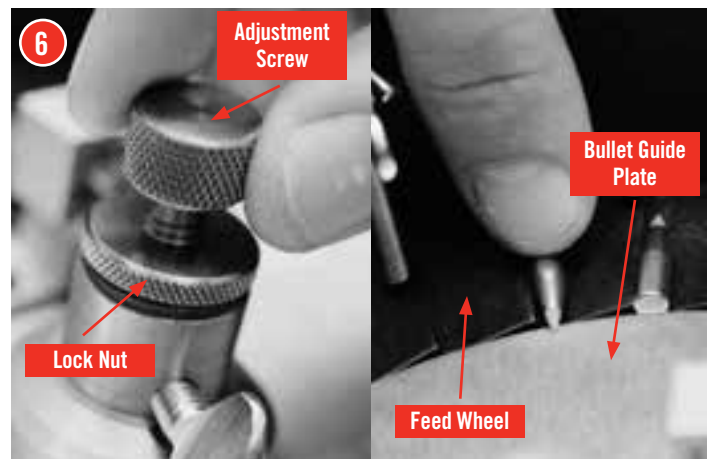

- 7 Place two bullets on the Bullet Feed Wheel (13) under the Bullet Wipers (27), base down against the Bullet Guide Plate (11). Loosen the Wiper Thumb Screw (28) and Wing Nuts (25) and adjust the wipers so that a base-down bullet tip passes under the wiper, but a tip-down bullet gets kicked out.

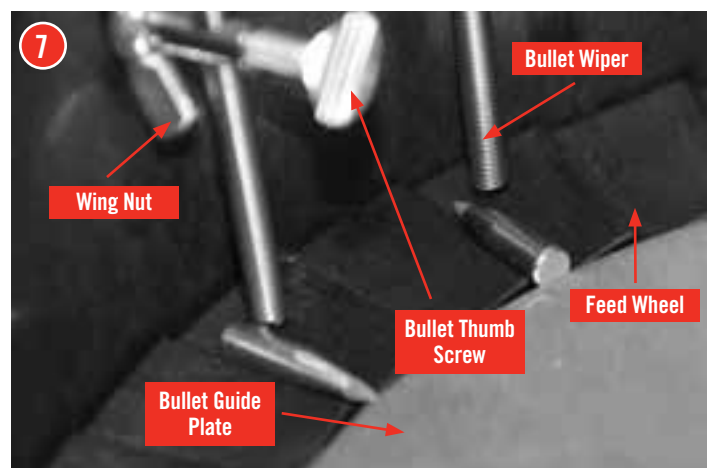

Switch Assembly

PARTS LIST & EXPLODED VIEW

Item No.	Production Part No.	Qty.	Description
67	399345	1	Switch Retainer, 22 Cal
68	399343	1	Feed Tube, 22 Cal
69	399347	3	4-40 X 11/16 Pan Head Screw

Item No.	Production Part No.	Qty.	Description
70	399364	1	Micro Switch (Cherry D42LR1XL)
71	399349	1	Feed Spring, 22 Cal
72	392458	3	4-40 Hex Nut

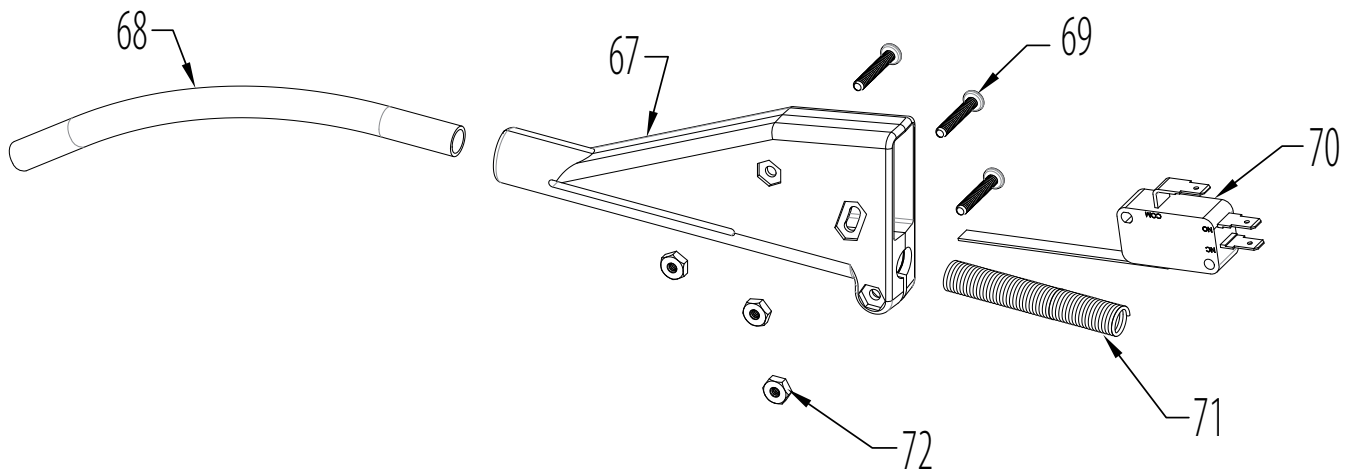

Feed Tube and Switch Connection

- 7 Run the Feed Spring (71) through the hole in the side of the Feeder Bowl (24) and connect to the Bullet Drop Funnel (5). Tighten the Knurled Thumb Screw (4) to secure the Feed Spring (71).

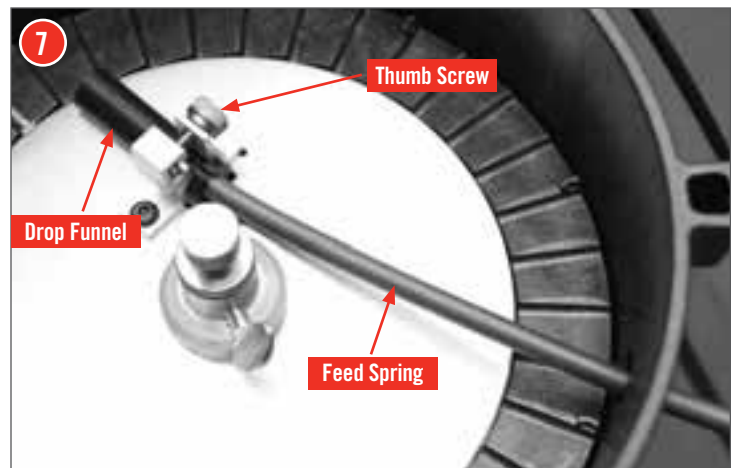

- 8 Plug the Shut-Off Switch Cable (35) into the Microswitch (70).

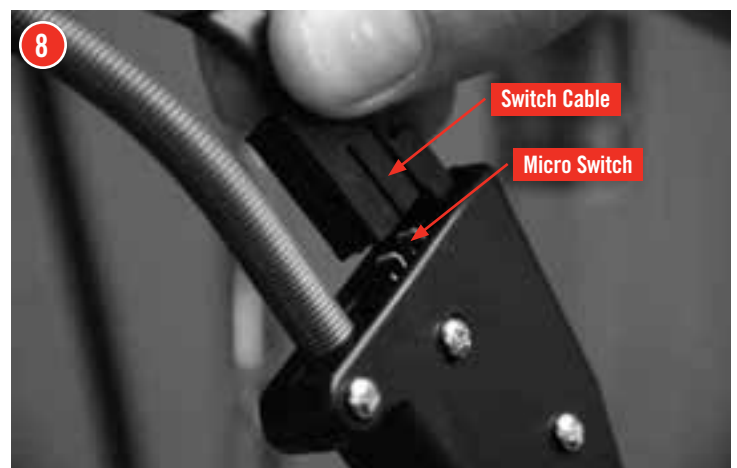

Hopper Testing

- 9 Plug in the Power Supply (34) and turn on the empty feeder using the 2 Position Switch (32). **If the feeder doesn't turn on, refer to 12A on the next page for adjustment procedure.**

Turn off, then put approximately 100 bullets in the Feeder Bowl (24). **Do not over fill.**

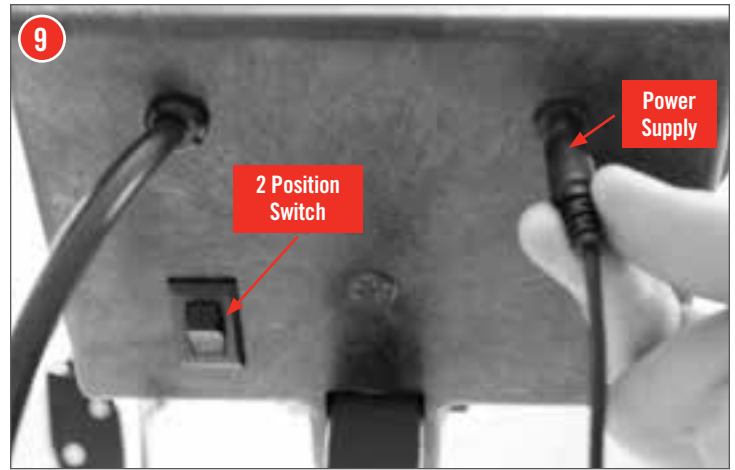

- 10 Hold the Feed Tube (68) and turn on the Feeder using the 2 Position Switch (32). Catch the bullets as they fall and make sure all bullets feed base-first. Adjust the Wiper Springs (27) and Bullet Guide Plate (11) if needed.

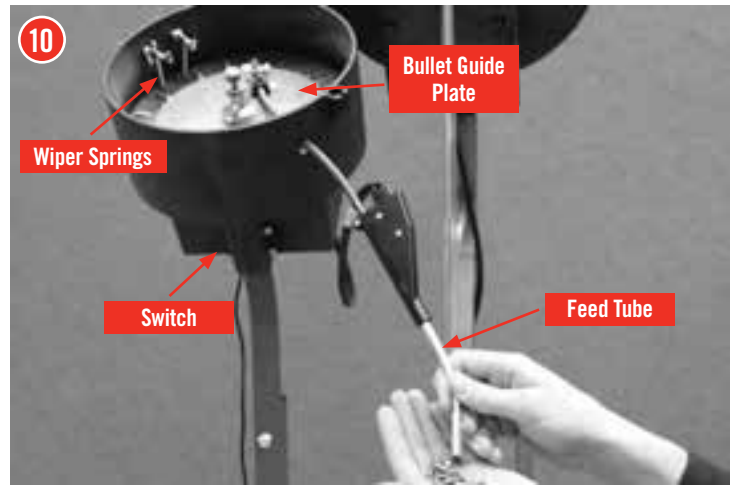

- 11 Cover the feed tube so the bullets fill to the switch lever, causing the hopper to shut off.

If the hopper does not switch off, turn off the 2 Position Switch (32), empty the feed tube, and refer to 12B on the next page.

If the hopper shuts off, no adjustment necessary. Skip step 12B on page 8.



Switch Adjustment (if necessary)

12 12A: Hopper does not start

If the hopper does not rotate, make sure the power supply is plugged in and the 2 Position Switch (32) is on. If it still does not rotate, loosen the screw shown in the image and slide DOWN slightly until a faint clicking of the switch can be heard. Re-tighten (slightly snug: do not over tighten).

12B: Hopper does not stop

If the hopper does not shut off, turn off the hopper with the 2 Position Switch (32) and empty the Feed Tube. Loosen the screw shown in the image and slide UP until the switch faintly clicks. Move it back down a small amount so it clicks again, then re-tighten (slightly snug: do not over tighten).

NOTE: Never push bullets upward through Switch Assembly. This will damage the Micro Switch.

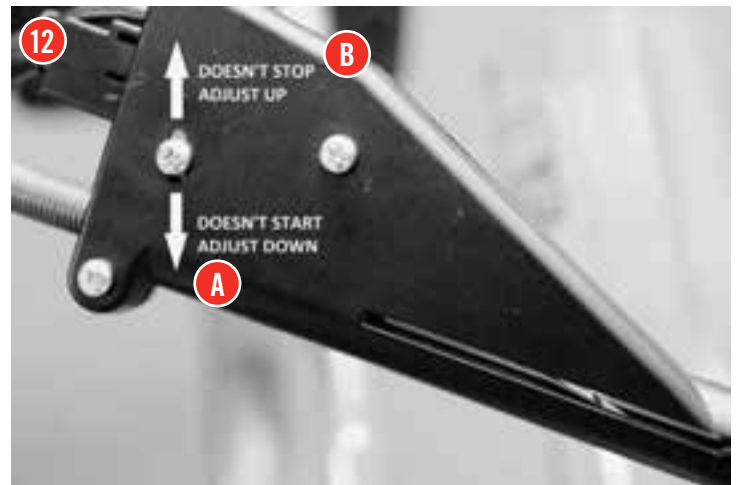

Feeder Adjustment

Feeder Block Selection

13 Select the tallest feed block (58 or 59) so the bullet tip protrudes slightly out of the top.

If the tip protrudes too far to feed (greater than ¼"), replace with the taller feed block. If the tip is recessed below the feed block, replace with the shorter block.

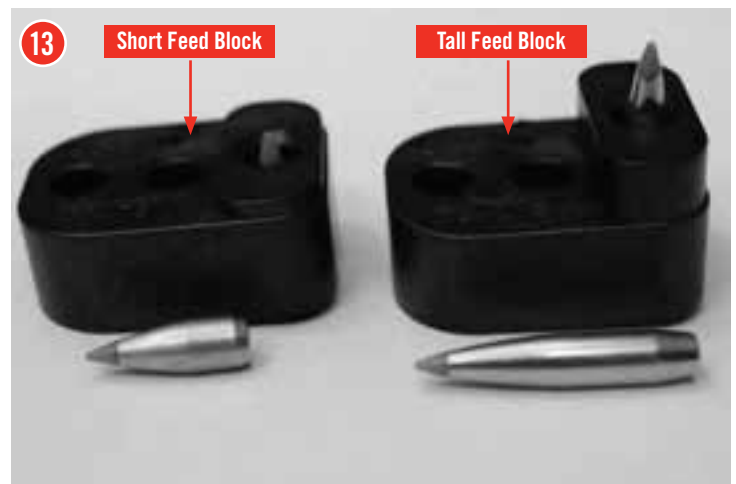

Feeder Block Installation (if necessary)

14 Remove the Shoulder Bolt (57) and Torsion Spring (60) and replace with the new feeder block.

Be sure that the Torsion Spring (60) is engaged in the slots in the Feeder Cap (62) and Feeder Block (58 or 59).

Finger tighten (1 inch-pound max) the Shoulder Bolt (57).

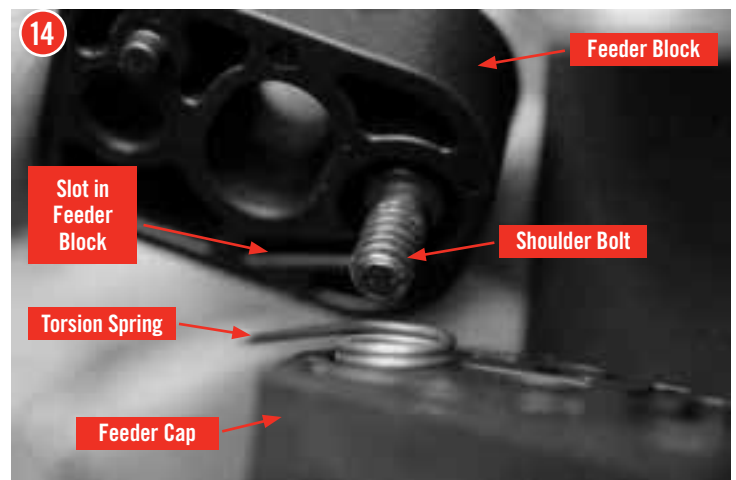

Bullet Drop Adjustment

15 Loosen the Lock Rings (44) and adjust the height of the Feed Tube Retainer (53) approximately 1/16" above the bullet tip.

Adjust location of the Feed Tube Retainer (53) so the bullets drop freely into the Feeder Block (58 or 59).

NOTE: If the bullets don't drop freely, the Feed Support Bracket (54) can be slightly adjusted by loosening the Pan Head Screws (56). Refer to photo 16A.

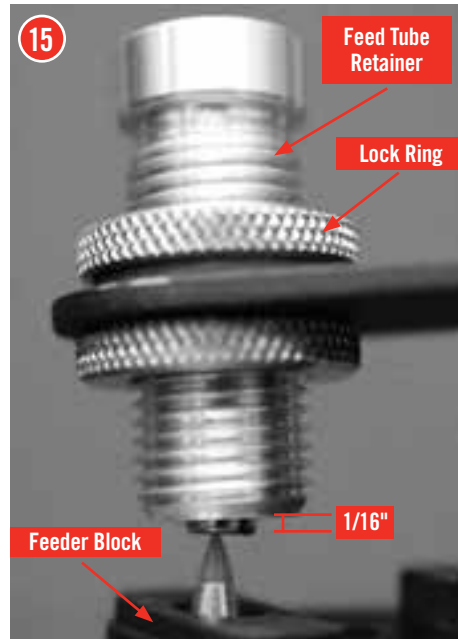

Feeder Body Removal

16 **16A:** Loosen the Thumb Screw (41) and slide the Feeder Clamp (40) up. The Feeder Body (63) will detach from the Die Body (51).

NOTE: The Bullet Ramp (66) and Compression Spring (64) will slide out of the bottom. Do not lose these.

16B: Set this assembly aside for attachment after die adjustment.

NOTE: The Bullet Ramp (66) may slide out of the Feeder Body (63). If this happens reassemble according to the drawing.

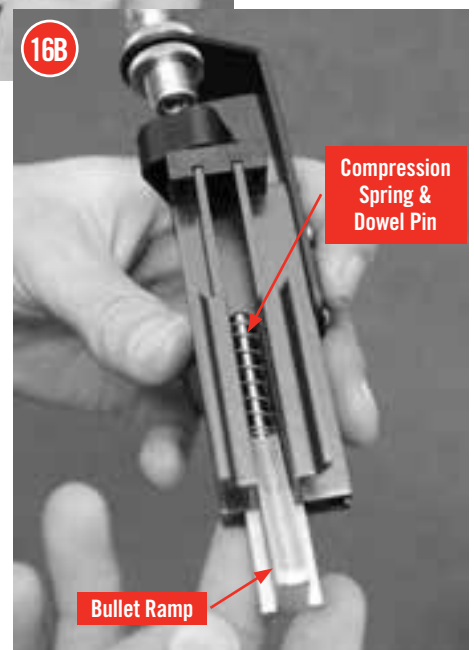
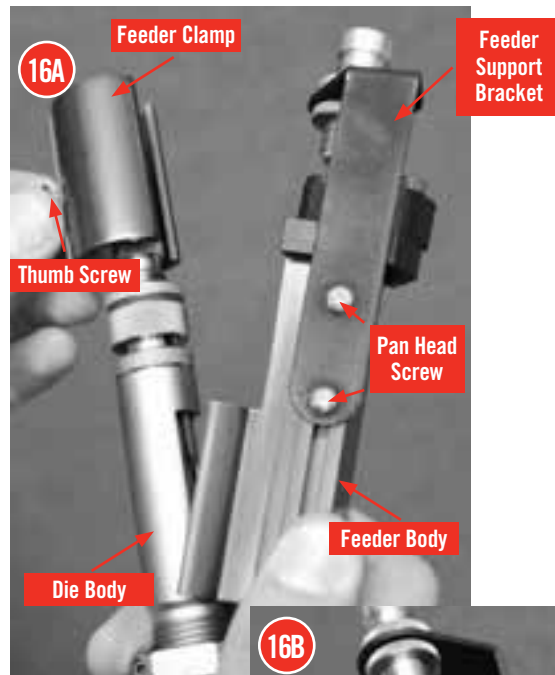

Lock-N-Load® Rifle Bullet Feeder Die

PARTS LIST

Item No.	Production Part No.	Qty.	Description
40	399327	1	Feeder Clamp, RBF
41	69006	1	Thumb Screw, 6-32 X .40
42	399322	1	Seat Adjust Screw, RBF
43	399325	1	Seating Stem, 22 Cal RBF
44	044800	3	Seat Adjust Lock Ring
45	398067	2	Rubber Washer
46	399320	1	Crimp Adjust Screw, RBF
47	398906	1	Crimp Adjust Lock Ring
48	480083	1	Crimp Adjust Locking O-Ring
49	399323	1	Alignment Sleeve, 22 Cal RBF
50	399371	2	Bullet Retaining O-Ring, RBF
51	399321	1	Die Body, RBF
52	044000	1	Lock Ring
53	399341	1	Feed Tube Retainer, 22 Cal RBF
54	399339	1	Feed Support Bracket (Black), RBF
55	392452	2	Hex Nut, 6-32
56	399340	2	Pan Head Screw, 6-32 X 5/16
57	399336	1	Shoulder Bolt, 1/4 X 5/8 10-25
58	399332	1	Feed Block, 22 Cal Short, RBF H.580
59	399333	1	Feed Block, 22 Cal Long, RBF H.780
60	399337	1	Torsion Spring - 1/4", RBF
61	399167	2	Pan Head Thread Cut, 4-40 X 3/8
62	399331	1	Feeder Cap, RBF
63	399328	1	Feeder Body, RBF
64	399338	1	Compression Spring - 1/4", RBF
65	399330	1	Dowel Pin, 1/4 X 2
66	399329	1	Bullet Ramp, RBF

EXPLODED VIEW

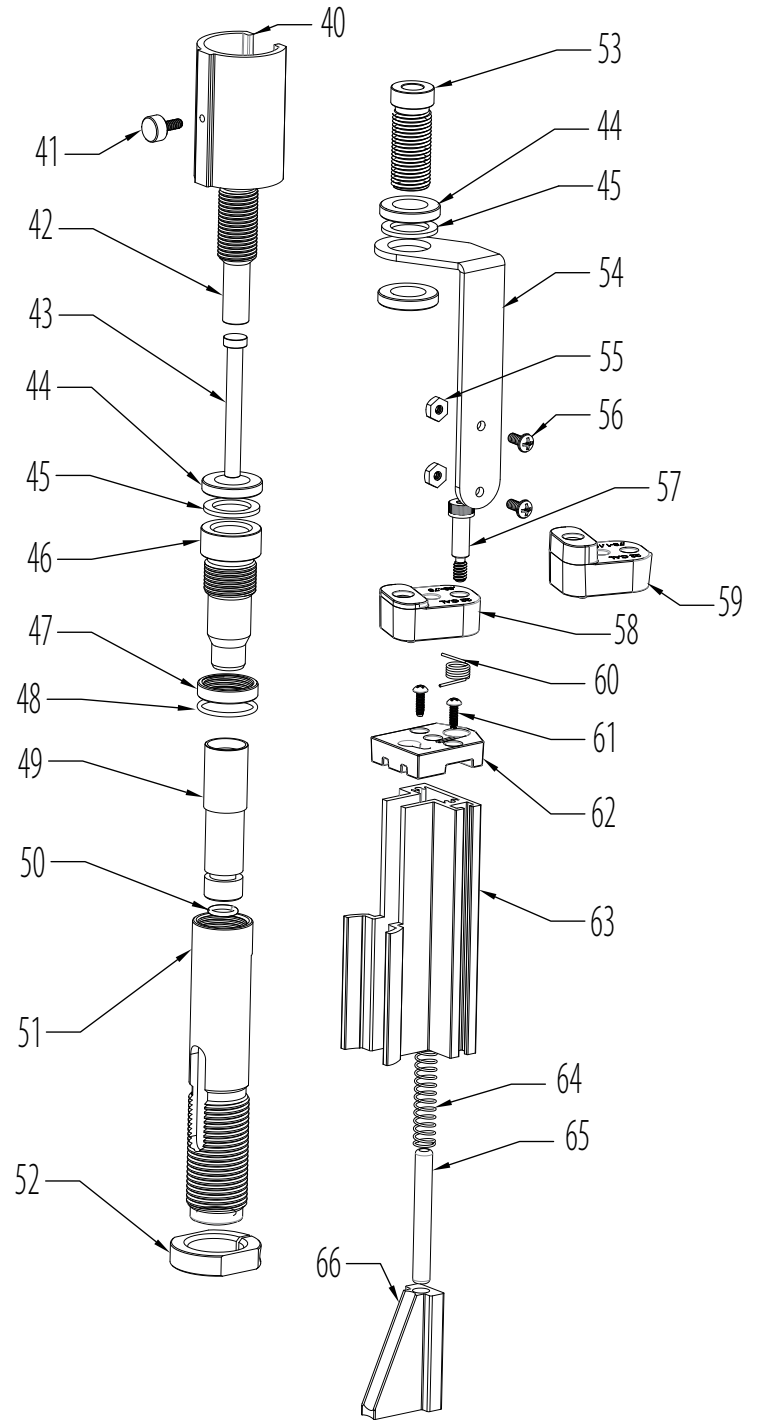

Die Adjustment

Preparation

17 As with all dies, disassemble the die and clean thoroughly. Reassemble according to the illustration. Do not attach the Feeder Body (63).

Set the distance between the Crimp Adjust Screw (46) and the Crimp Adjust Lock Ring (47) to 0.10" (about 2 turns back). The Crimp Adjust Lock Ring should have firm tension on the O-Ring (48) against the Die Body (51).

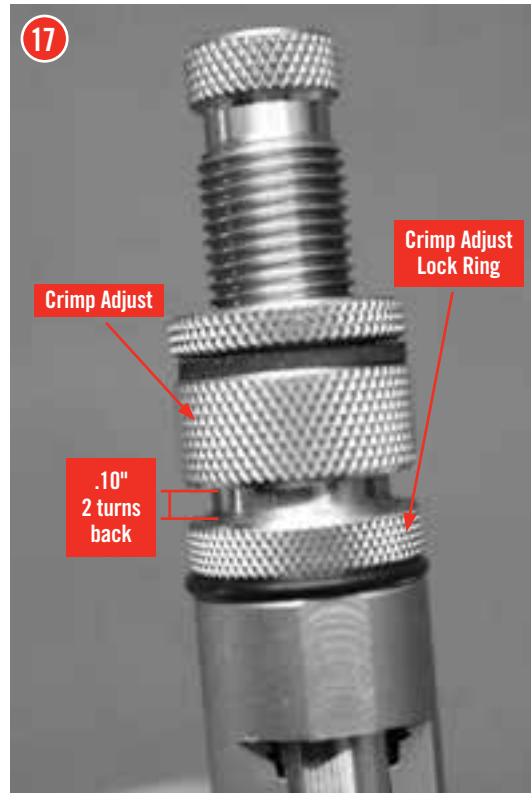

18 Loosen the Seat Adjust Lock Ring (44) and back out the Seat Adjust Screw (42) about one inch to ensure that the bullets won't be seated too deep.

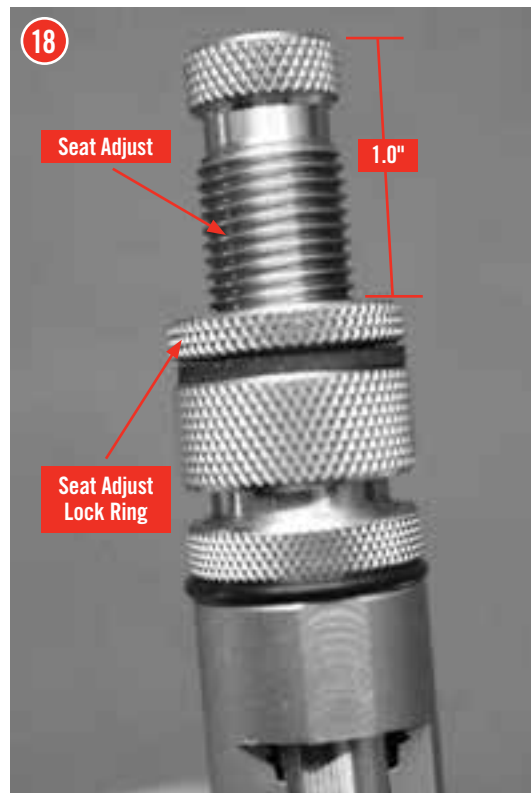

Die Placement

- 19 With a chamfered case in the shell plate, raise the press ram to the top of its stroke. Screw the assembled die into the press until resistance is felt. This resistance is the case starting to crimp in the Alignment Sleeve (49). Back the die off approximately half of a turn.

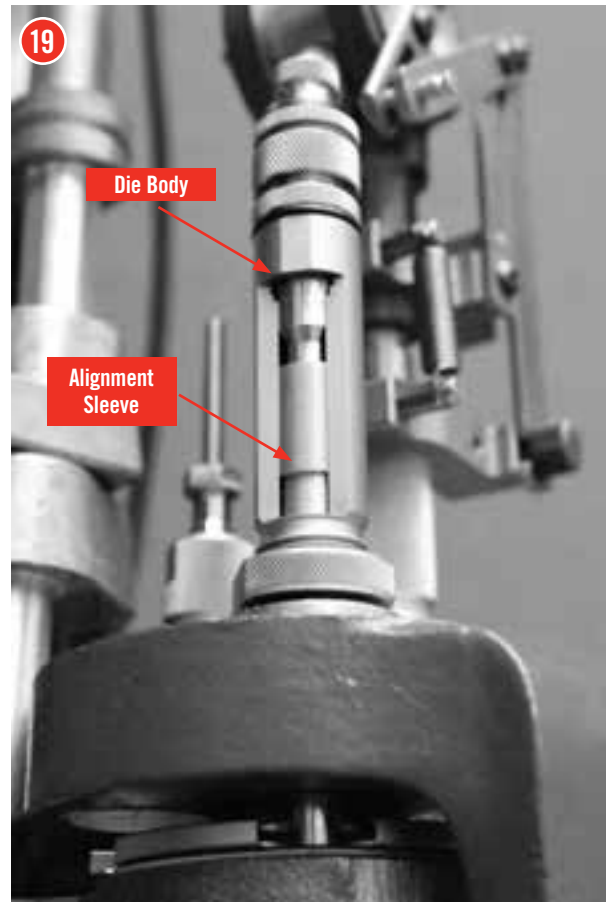

- 20 Screw the Sure-Loc® Lock Ring (52) down against the press or Lock-N-Load® Bushing and lock into place by tightening the cap screw.

Orient the die so the opening faces the outside of the press by removing and rotating the Lock-N-Load® Bushing. This will allow the Feeder Body (63) to be attached in a later step.

NOTE: If your press does not feature the Lock-N-Load® Bushing system, the die will have to be rotated back so the opening faces the outside of the press.

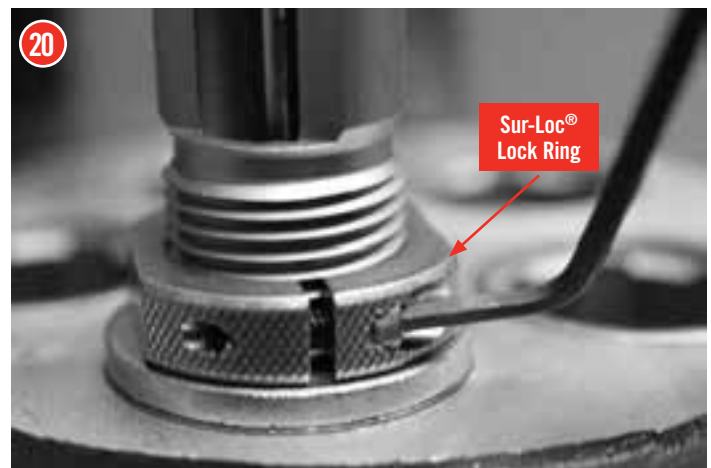

Bullet Seating Depth

- 21 Lower the press ram. Make sure there is not a bullet in the die from a previous loading session. Drop a bullet into the opening of the Die Body (51). The bullet should push aside the Seating Stem (43) and stop inside the Alignment Sleeve (49) against the Retaining O-Ring (50).

Raise the press ram guiding the case mouth into the Alignment Sleeve (49). While the press ram is at the top of the stroke, thread the Seat Adjust Screw (42) into the die until resistance is felt. This is the bullet starting to seat in the case.

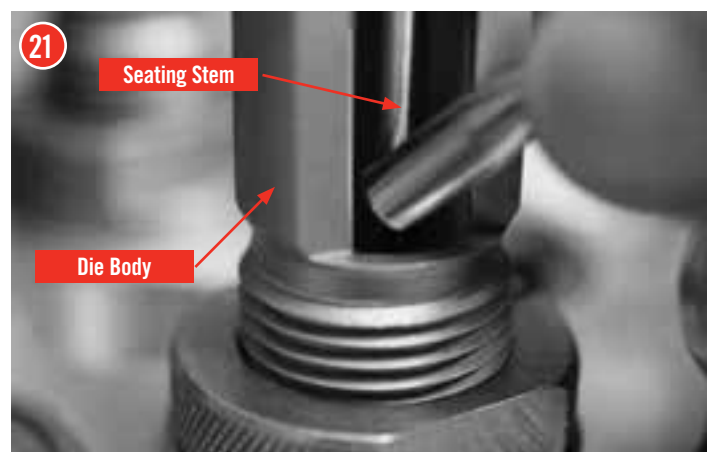

22 Set the bullet seat depth by lowering the press ram, threading the Seat Adjust Screw (42) into the die and raising the press ram again until the desired seating depth/cartridge length is obtained. Make sure the Crimp Adjust Screw (46) does not move when adjusting the seating depth.

Note: Do not, at this time, tighten the Seat Adjust Lock Ring (44).



Crimp Adjust (if desired)

23 With the cartridge in the Shell Plate, raise the press ram to the top of its stroke.

Loosen the Crimp Adjust Lock Ring (47) several turns while holding the Crimp Adjust Screw (46)

Hold the Seat Adjust Screw (42) from turning and thread the Crimp Adjust Screw into the die until resistance is felt. This resistance is, again, the case starting to crimp.

Continue setting crimp by lowering the press ram, holding the Seat Adjust Screw (42), threading the Crimp Adjust Screw (46) into the die in 1/8 turn increments, and raising the press ram again until the proper crimp is obtained.

NOTE: Excessive crimp may cause case bulging or bullet deformation.

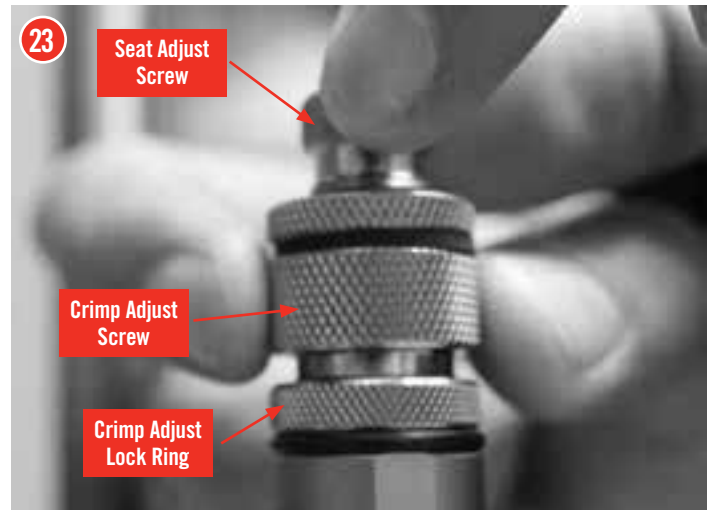

Tune & Lock the Die

Next, lower the press ram and remove the cartridge. Place the next set of components in the press and seat/crimp another round.

Fine tune the crimp/seat depth if necessary. When adjusting the Crimp Adjust Screw (46), hold the Seat Adjust Screw (42). When adjusting the Seat Adjust Screw (42), hold the Crimp Adjust Screw (46). Doing this will allow the crimp amount to be adjusted without moving the seating depth and vice versa.

Once the crimp amount and the seat depth have been obtained, tighten the Crimp Adjust Lock Ring (47) while holding the Crimp Adjust Screw (46) so it doesn't move. Then tighten the Seat Adjust Lock Ring (44) while holding the Seat Adjust Screw (42) so it doesn't turn. Your die is now set to seat and crimp in one step.

Feeder Attachment

The Bullet Ramp (66) and Compression Spring (64), must be inside the Feeder Body (63). **Refer to photo 16B on page 9.**

The press ram must be lowered and the alignment sleeve down.

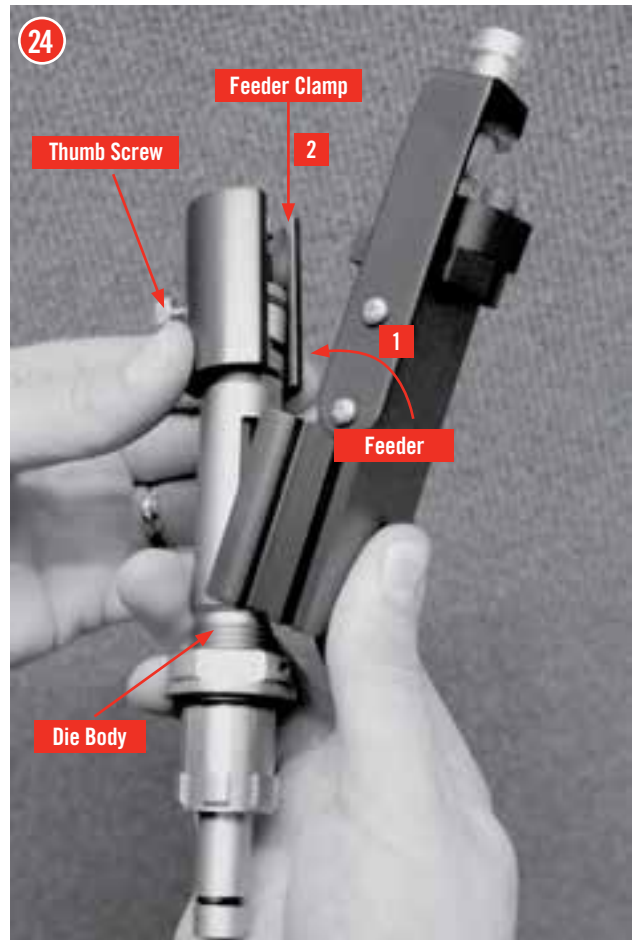

24 Slide the Feeder Body (63) onto the Die Body (51). Slide the Feeder Clamp (40) down over the Die Body (51) and Feed Body (63) and tighten the Thumb Screw (41).

NOTE: The Feeder Body can be attached while the die is in the press. The Lock-N-Load® Bushing System allows the die to be easily removed for assembly.

Bullet Feed Tube Attachment

25 **25A:** Slide the Bullet Feed Tube (68) into the Feed Tube Retainer (53).

25B: Adjust the hopper height by loosening the Wing Nuts (25) sliding the top Support tube (37) up or down, and re-tightening the Wing Nuts (25). adjust the height to obtain smooth feeding through the Feed Spring (71).

Turn on the hopper and allow the tube to fill. Make sure that the bullets feed base down, and that the hopper switches off when the tube fills.

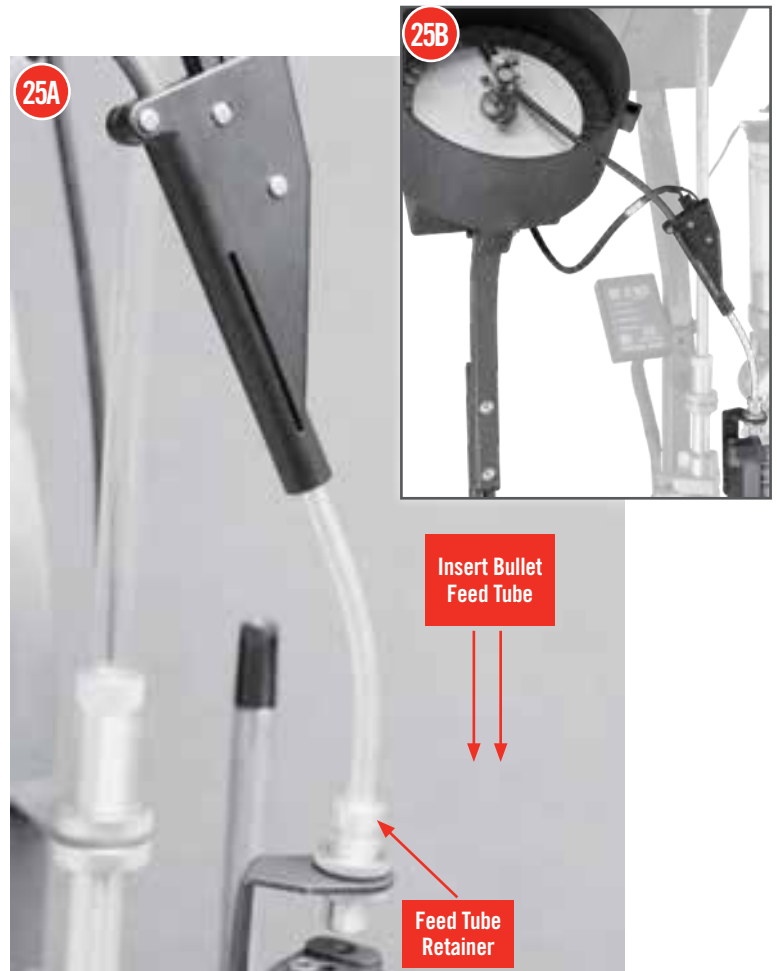

Load

- 26 Put a case in the shell holder and cycle the press ram. The bullet in the Alignment Sleeve (49) will seat into the case. Simultaneously the Feed Block (58 or 59) will rotate and drop a bullet.

Note: *The first stroke of the press will not seat a bullet if there isn't a bullet in the Alignment Sleeve (49).*

- 27 When the ram is lowered, the bullet will slide down the Bullet Ramp (66), push aside the Seating Stem (43), and drop into the Alignment Sleeve (49). The Bullet Retaining O-Ring (50) will hold the bullet in preparation for the next press cycle.

- 28 Subsequent cycles will simultaneously seat a bullet and feed the next bullet.

Make smooth, consistent press strokes.

Partial press cycles may or may not feed a bullet and jamming may occur.

If the press is double stroked and a bullet is not seated, two bullets could be fed into the die. If in doubt, disassemble the die and clear any bullets out of the die before proceeding.

Be certain the die is clean so the bullets can slide past the seating stem and drop into the alignment sleeve.

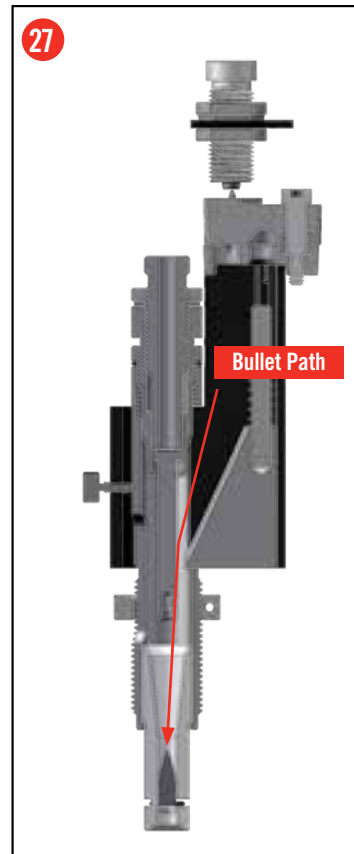
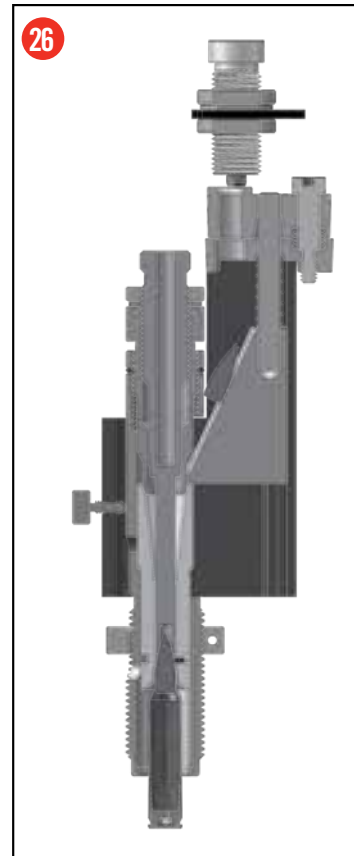

Troubleshooting the Lock-N-Load® Rifle Bullet Feeder

Problems	Possible Causes & Solutions
Hopper does not turn on	<ul style="list-style-type: none"> • Switch cable is not connected to the micro switch. Connect the cable to the switch (see step 8). • Power supply is not plugged in. Plug in power supply (see step 9). • Power switch is not turned on. Turn on switch (see step 9). • Micro switch is out of adjustment. Adjust the switch (see step 12A). • Bullet or other object is stuck in the switch housing. Clear the obstruction.
Bullets feeding up-side-down	<ul style="list-style-type: none"> • The bullet guide plate is too high. Lower and adjust the bullet guide plate (see step 6). • Wipers are not adjusted correctly. Adjust wipers (see step 7). • Using round nose or flat tipped bullets. Do not use these bullets.
Bullets not feeding through feed spring/tube	<ul style="list-style-type: none"> • Bullets feeding upside down can cause a jam. Perform feeder adjustment (see step 6 & 7). • Support tube is too high or too low. The feed spring may be too tight or too loose. Adjust hopper height (see step 25B). • Incorrect hopper mounting holes used. Mount the hopper using the bottom and middle mounting holes to obtain the proper hopper feed angle (see step 4). • A bullet of a larger caliber or other debris may clog the feed system. Clear and discard any debris.
Bullets don't drop into feed block	<ul style="list-style-type: none"> • Feed tube retainer doesn't line up with feed block. Adjust feed tube retainer (see step 15). • Feed tube retainer is adjusted too high. Adjust feed tube retainer down, but not below the tip of the bullet (see step 15). • Improper feeder block selection. The short feeder block may not consistently drop bullets longer than 0.78" long (see step 13).
Feeder Blocks do not rotate	<ul style="list-style-type: none"> • Incorrect feeder block selection. If the bullet is shorter than the feed block it will not be able to rotate. Select a shorter feed block (see step 8). • Feed tube retainer is adjusted too low. Adjust feed tube retainer up (see step 15). • Incorrect bullet selection. 22 cal bullets shorter than 0.58" long and longer than 1.13" will not feed in this die and may cause jamming. • Bullet ramp is not inside of the die. Put the feeder ramp and spring inside the die (see step 16B).
Die jams	<ul style="list-style-type: none"> • Extra bullets in the die. WARNING! MULTIPLE BULLETS IN THE DIE MAY CAUSE JAMMING. IF THE PRESS IS PARTIALLY CYCLED OR IF AN EXTRA BULLET IS DROPPED INTO THE DIE, DANGEROUS CONDITIONS MAY OCCUR. REMOVE ANY EXTRA BULLETS TO CLEAR A JAM. • A dirty die may cause the seating stem to hang crooked and prevent the die from cycling. Clean the die (see step 17). • Table may not be level. If the die is not level, the seating stem may not move to center after a bullet passes by. Mount your press on a level table.
Bullets seat hard	<ul style="list-style-type: none"> • Cases need to be cleaned, chamfered, de-burred, and have the proper neck inner diameter prior to loading. Failure to do so may not work in the press and will reduce the quality of your loaded ammo. • Two bullets in the die. WARNING! IF YOU SHORT STROKE THE PRESS OR DROP AN EXTRA BULLET IN THE DIE, DANGEROUS LOAD CONDITIONS CAN OCCUR.

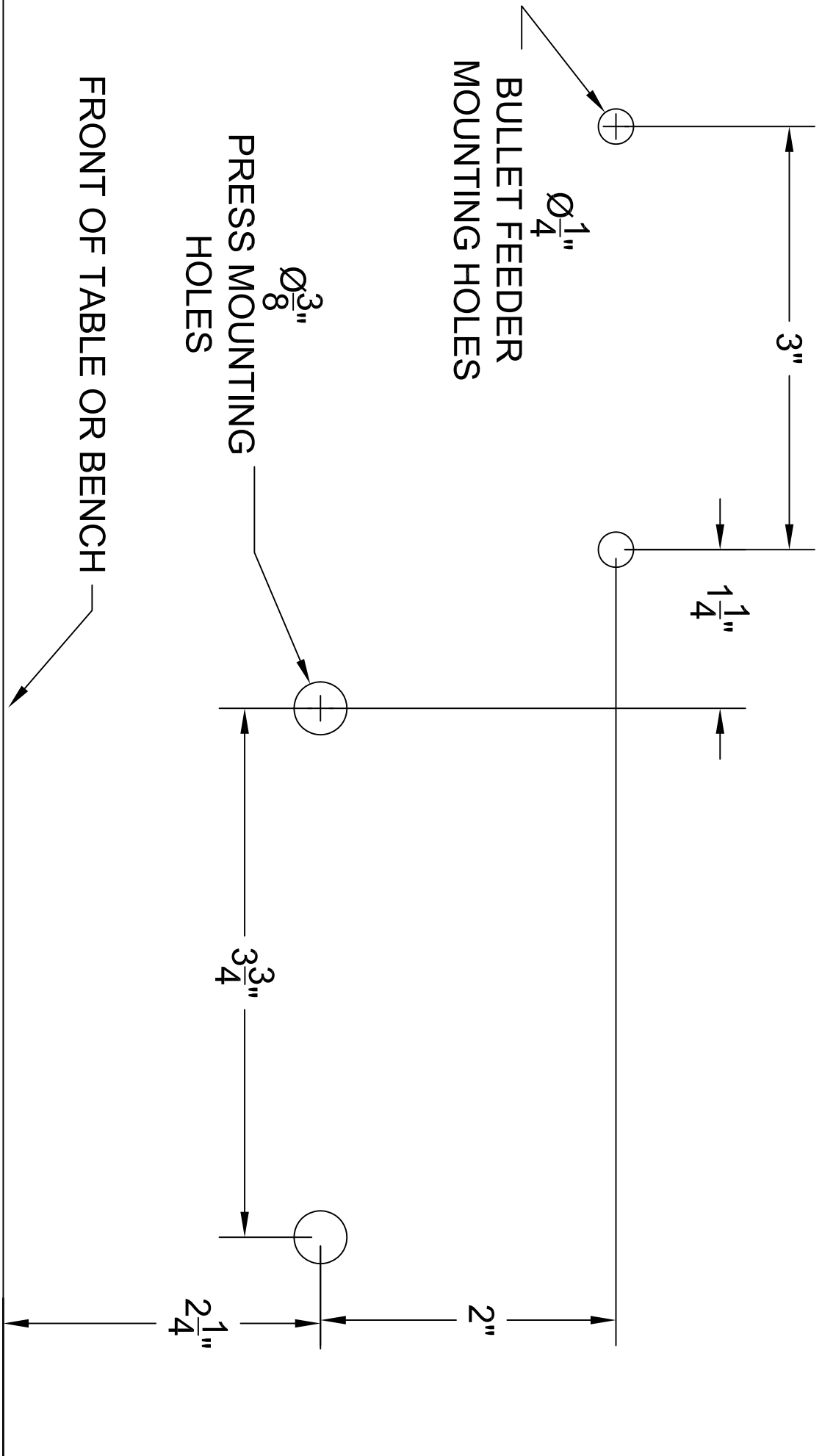

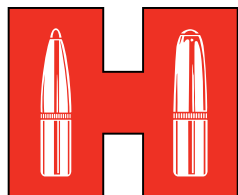

Hornady[®]
Accurate. Deadly. Dependable.

P.O. Box 1848, Grand Island, Nebraska 68802-1848
308-382-1390 • 800-338-3220 • Fax: 308-382-5761
www.hornady.com • Hornady.com/contact_us